

## iA(intelligent Auto) H.265 PTZ Camera

Panasonic WV-S6130 captures the highest quality images automatically even in very challenging and fast-changing surveillance environments. Intelligent Auto (iA) monitors scene dynamics and motion to adjust key camera settings automatically in real-time reducing distortion such as motion blur on moving objects. New industry-leading 144dB dynamic range delivers balanced scene exposure in dynamic and extreme-backlit lighting environments. In addition, color night vision provides outstanding low-light performance with accurate color rendition and saturation from i-Pro's 1/3" sensor, rivaling the performance of costlier 1/2" sensor cameras in the market. Adopting H.265 Smart Coding technology, intelligently reduces bandwidth efficiency of up to 95%\* over H.264 for longer recording and less storage. Cameras out-of-the-box, support full data encryption streaming and is compliant to FIPS 140-2 Level 1 standards to keep your video secured. \*Value in Advanced mode. It depends on the scene.

### Extreme image quality for evidence capturing under challenging conditions

- Sharp and clear image of moving objects with Intelligent Auto
- Outstanding low light performance in true color with low noise for night time applications
- Super Dynamic 144dB for backlit situation by headlights and shadows on the streets at night
- Long life Pan/Tilt gear mechanism

### Extreme H.265 compression with new Smart Coding

- Longer recording, less storage compared to H.264 based compression techniques
- New self-learning ROI\* encoding (Auto VIQS) dynamically detect motion areas to keep vehicles and human in good picture quality while lowering your bandwidth \* Region of Interest

### Extreme Data Security

- Full encryption SD card edge recording to keep your data safe
- FIPS 140-2 Level 1 compliant
- Full end-to-end system encryption with supported VMS and devices to protect from IP snooping/spoofing and detect data alteration

### Key Features

- Full-HD 1920x1080 60fps
- Durable Pan/Tilt gear mechanism
- iA (intelligent Auto)
- Extreme Super Dynamic 144dB
- Color night vision (0.001 to 0.015 lx)

### Applications

- Retail
- Banks
- Hospitals
- Building



## Specifications

<b>Camera</b>	Image Sensor	Approx. 1/2.9 type MOS image sensor
	Minimum Illumination	Color : 0.015 lx, BW : 0.006 lx (F1.6, Maximum shutter : Off (1/30 s), AGC : 11) Color : 0.001 lx, BW : 0.0004 lx (F1.6, Maximum shutter : Max. 16/30s, AGC : 11) **
	Intelligent Auto	On / Off
	Shutter Speed	1/30 Fix to 1/10000 Fix *1/30 Fix to 2/120 Fix is available during 30 fps mode only. *1/60 Fix is available during 60 fps mode only.
	Super Dynamic <sup>2</sup>	On / Off, the level can be set in the range of 0 to 31.
	Dynamic Range	144 dB (Super Dynamic : On)
	Image Settings	Gain (AGC), White balance
	Image Compensation	Adaptive black stretch, Back light compensation (BLC), Fog compensation, High light compensation (HLC), Digital noise reduction
	Color/BW (ICR)	Off / On / Auto1 (Normal) / Auto2 (IR Light) / Auto3 (SCC)
	Video Motion Detection (VMD)	On / Off, 4 areas available
	Intelligent VMD (i-VMD) <sup>3</sup>	Type 4 *optional plug-in software WV-SAE200
	Stabilizer <sup>3</sup>	On / Off (available only in the 30 fps mode)
	Privacy Zone	Filling / Pixelate / Off (up to 32 zones available)
	Camera Title (OSD)	On / Off up to 20 characters (alphanumeric characters, marks)
	<b>Lens</b>	Zoom Ratio
Digital (electronic) zoom		16x
Focal length		4.0 mm – 84.6 mm (5/32 inches – 3 -11/32 inches)
Maximum Aperture Ratio		1 : 1.6 (WIDE) – 1 : 4.5 (TELE)
Focus range		1.5 m (4ft 11- 1/16 inches) – ∞
Angular Field of view		[16 : 9 mode] Horizontal : 3.5 ° (TELE) – 74 ° (WIDE) Vertical : 2.0 ° (TELE) – 42 ° (WIDE) [4 : 3 mode] Horizontal : 3.0 ° (TELE) – 61 ° (WIDE) Vertical : 2.3 ° (TELE) – 46 ° (WIDE)
<b>Pan/tilt</b>		Panning Range
	Panning Speed	Manual : Approx. 0.5°/s – 100°/s Preset : Up to approx. 300°/s
	Tilting Range	Operational range: -30 ° – 90 ° (level – downward)
	Tilting Speed	Manual : Approx. 0.5°/s – 100°/s Preset : Up to approx. 100°/s
	Preset Positions	256 positions
	Auto Mode	Auto track <sup>3</sup> / Auto pan/ Preset sequence/ Patrol
	Self Return	10 s/ 20 s/ 30 s/ 1 min/ 2 min/ 3 min/ 5 min/ 10 min/ 20 min/ 30 min/ 60 min
<b>Browser GUI</b>	Camera Control	Pan/Tilt, Zoom, Focus, Auto mode, Brightness, Preset, AUX, Rec. on SD, Log, Viewer software
	Audio	Mic (Line) Input : On / Off Volume adjustment : Low / Middle / High Audio Output : On / Off Volume adjustment : Low / Middle / High
	GUI / Setup Menu Language	English, Italian, French, German, Spanish, Portuguese, Russian, Chinese, Japanese
<b>Network</b>	Network IF	10 Base-T / 100 Base-TX, RJ45 connector
	Resolution	<b>*2 mega pixel [16 : 9] (30/60 fps)</b> 1920x1080, 1280x720, 640x360, 320x180
	H.265 / H.264 JPEG (MJPEG)	<b>*3 mega pixel [4 : 3] (30 fps)</b> 2048x1536, 1280x960, 800x600, VGA, 400x300, QVGA *Used by super resolution techniques
	H.265/ H.264 <sup>4</sup>	Transmission Mode Constant bit rate / VBR / Frame rate / Best effort
	JPEG	Transmission Type Unicast / Multicast Image Quality 10 steps

\*1 Converted value

\*2 Super Dynamic function is automatically set off on 60 fps mode.

\*3 Stabilizer, Auto track, Smart Facial Coding, i-VMD, can not be used at the same time.

\*4 Transmission for 4 streams can be individually set.

<b>Network</b>	Smart Coding	Smart Facial Coding <sup>3</sup> : On(Smart Facial Coding)/ On(AUTO VIQS)/ Off * Smart Facial Coding is only available with Stream(1). GOP(Group of pictures) control : On(Advanced)/ On(Low)/ On(Mid)/ Off * On(Advanced) is only available with H.265.	
	Audio Compression	G.726 (ADPCM) : 16 kbps / 32 kbps, G.711 : 64 kbps, AAC-LC <sup>5</sup> : 64 kbps / 96 kbps / 128 kbps	
	Audio transmission mode	Off / Mic (Line) input / Audio output / Interactive (Half duplex) / Interactive (Full duplex)	
	Supported Protocol	IPv6 : TCP/IP, UDP/IP, HTTP, HTTPS, RTP, FTP, SMTP, DNS, NTP, SNMP, DHCPv6, MLD, ICMP, ARP, IEEE 802.1X, DiffServ IPv4 : TCP/IP, UDP/IP, HTTP, HTTPS, RTSP, RTP, RTP/RTCP, FTP, SMTP, DHCP, DNS, DDNS, NTP, SNMP, UPnP, IGMP, ICMP, ARP, IEEE 802.1X, DiffServ	
	Maximum concurrent access number	Up to 14 users (Depends on network conditions)	
	SDXC/SDHC/SD	H.265 / H.264 recording : Manual REC / Alarm REC (Pre/Post) / Schedule REC / Backup upon network failure JPEG recording : Manual REC / Alarm REC (Pre/Post) / Backup upon network failure	
	Memory Card (Option)	Compatible SDXC/SDHC/SD Memory Card : Panasonic 2 GB, 4 GB*, 8 GB*, 16 GB*, 32 GB*, 64 GB**, 128 GB** 256 GB** model *SDHC card, ** SDXC card (except miniSD card and microSD card)	
	Mobile Terminal Compatibility	iPad / iPhone, Android™ mobile terminals	
	<b>Alarm</b>	Alarm Source	3 terminals input, VMD alarm <sup>6</sup> , Command alarm, Audio detection alarm, Auto track alarm
		Alarm Actions	SDXC/SDHC/SD memory recording, E-mail notification, HTTP alarm notification, Indication on browser, FTP image transfer, Panasonic protocol output
<b>Input/ Output</b>	Monitor Output (for confirmation)	VBS : 1.0 V [p-p] / 75 Ω, composite, ø3.5 mm mini jack An NTSC or PAL signal can be outputted from camera	
	Audio Input	ø3.5 mm stereo mini jack (stereo input) Input impedance: Approx. 2 kΩ (unbalanced) (Applicable microphone: Plug-in power type) Supply voltage: 2.5 V ± 0.5 V	
	Audio Output	ø3.5 mm stereo mini jack (stereo output) Output impedance : Approx. 600 Ω (unbalanced)	
<b>General</b>	External I/O Terminals	ALARM IN 1 (Black & white input, Auto time adjustment input) (x1), ALARM IN 2 (ALARM OUT) (x1), ALARM IN 3 (AUX OUT) (x1)	
	Power Source and Power Consumption	DC12 V 1 A, Approx. 12 W PoE(IEEE802.3af) DC 48 V 250 mA, Approx. 12 W (Class0 device)	
	Ambient Operating Temperature	-10 °C to +50 °C (14 °F to 122 °F) (Ceiling / Camera mount bracket) -10 °C to +40 °C (14 °F to 104 °F) (Desktop / Tripod)	
	Ambient Operating Humidity	10 to 90 % (no condensation)	
	Dimensions	<b>Including the decorative cover</b> ø185 mm × 157 mm (H) (ø7-9/32 inches × 6-3/16 inches (H)) <b>Excluding the decorative cover(place the camera upside-down)</b> ø115 mm × 155 mm (H) (ø4-17/32 inches × 6-3/32 inches (H))	
Mass (approx.)	Approx. 1.1 kg (2.43 lbs) Including Camera mount bracket, decorative cover : Approx. 200 g (0.44 lbs)		
Finish	Camera : PMMA resin, Fine silver Decorative cover : PC / ABS resin, Fine silver		

\*5 Only use AAC-LC (Advanced Audio Coding - Low Complexity) when recording audio on an SD memory card.

\*6 Including alarms from Plug-in Software

## Appearance

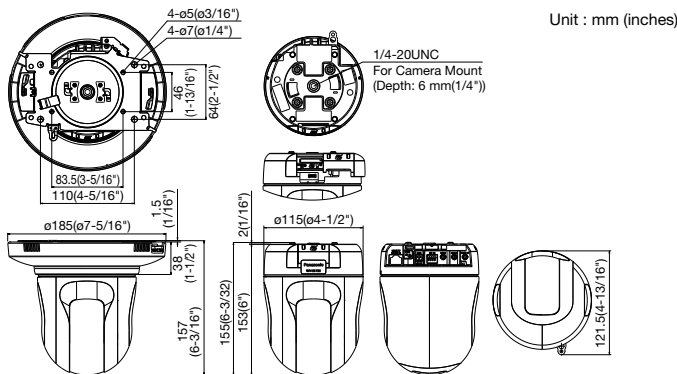

Unit : mm (inches)

### Trademarks and registered trademarks







- iPad and iPhone are registered trademarks of Apple Inc.
- Android is a trademark of Google Inc.
- ONVIF and the ONVIF logo are trademarks or registered trademarks of ONVIF Inc.
- All other trademarks identified herein are the property of their respective owners.

### Important

- Safety Precaution : Carefully read the Important Information, Installation Guide and operating instructions before using this product.
- Panasonic cannot be responsible for the performance of the network and/or other manufacturers' products used on the network.

## Optional Accessories

\* This catalog is provided for all over the world. Some accessories may not be available in some countries.

<b>Ceiling Mount Bracket</b> <b>WV-Q105A</b> 	<b>Wall Mount Brackets</b> <b>WV-Q158C</b> (Clear) <b>WV-Q158S</b> (Smoke)  (Smoke Type)	<b>Ceiling Mount Brackets</b> <b>WV-Q159C</b> (Clear) <b>WV-Q159S</b> (Smoke)  (Smoke Type)
<b>Ceiling Mount Brackets</b> <b>WV-Q160C</b> (Clear) <b>WV-Q160S</b> (Smoke)  (Smoke Type)	<b>Inner Cover</b> <b>WV-Q161</b> 	
<b>Plug-in Software for i-VMD</b> <b>WV-SAE200</b> i-VMD is possible to detect objects in the specified area by advanced video analysis technology. i-VMD : Intruder Detection, Loitering Detection, Direction Detection, Scene Change Detection, Object Detection, Cross Line Detection  Notification sent to the monitoring screen		

• Masses and dimensions are approximate. • Specifications are subject to change without notice.

DISTRIBUTED BY :

# Panasonic

<https://security.panasonic.com>

<https://www.facebook.com/PanasonicNetworkCamera>

(2A-196AA)